

FLUKE®

i410/i1010

AC/DC Current Clamp

Instruction Sheet

Safety Information

⚠ ⚠ Read First: Safety Information

To ensure safe operation and service of the current clamp, follow these instructions:

- Read all operating instructions before use and follow all safety instructions.
- Use the Current Clamp only as specified in the operating instructions, otherwise the clamp's safety features may not protect you.
- Adhere to local and national safety codes. Individual protective equipment must be used to prevent shock and arc blast injury where hazardous live conductors are exposed.
- Do not hold the Current Clamp anywhere beyond the tactile barrier. See Features and Connections.
- Before each use, inspect the Current Clamp. Look for cracks or missing portions of the clamp housing or output cable insulation. Also look for loose or weakened components. Pay particular attention to the insulation surrounding the jaws.
- Never use the clamp on a circuit with voltages higher than 600 V (CAT. III) or a frequency higher than 400 Hz (i410) or 2 kHz (i1010).
 - CAT III equipment is designed to protect against transients in equipment in fixed equipment installations, such as distribution panels, feeders and short branch circuits, and lighting systems in large buildings.
- Use extreme caution when working around bare conductors or bus bars. Contact with the conductor could result in electric shock.
- Use caution when working with voltages above 60 V dc, 30 V ac rms or 42 V ac peak. Such voltages pose a shock hazard.

Features and Connections

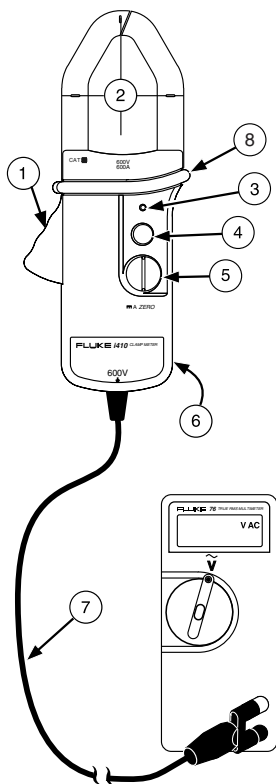

ar001i.eps

- ① Jaw Lever
- ② Jaw Centering Marks
- ③ ON Indicator
- ④ ON/OFF Switch
- ⑤ Zero Adjust
- ⑥ Battery Access
- ⑦ Output Cable
- ⑧ Tactile Barrier

Minimum voltmeter requirements:

- Accepts safety-shrouded banana plugs.
- Can display 1 mV (0.1 mV preferred)
- Accuracy $\geq 0.75\%$
- Input impedance $\geq 1\text{ M}\Omega$, $\leq 100\text{ pF}$.

Measuring DC Current

Maximum: 400 A dc (i410) or 1000 A dc (i1010)

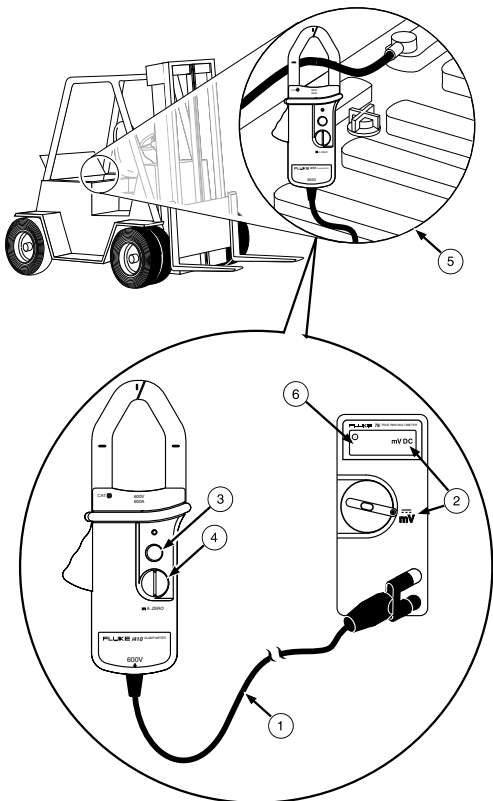

ar002i.eps

- 1 Connect to voltmeter.
- 2 Select mV dc.
- 3 Set ON.
- 4 Adjust ZERO (jaws empty.)

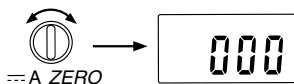

ar006i.eps

- 5 Clamp and center around conductor.
- 6 Read voltmeter (1 mV = 1 A.)

Measuring AC Current

Maximum: 400 A ac rms (i410) or 600 A ac rms (i1010)

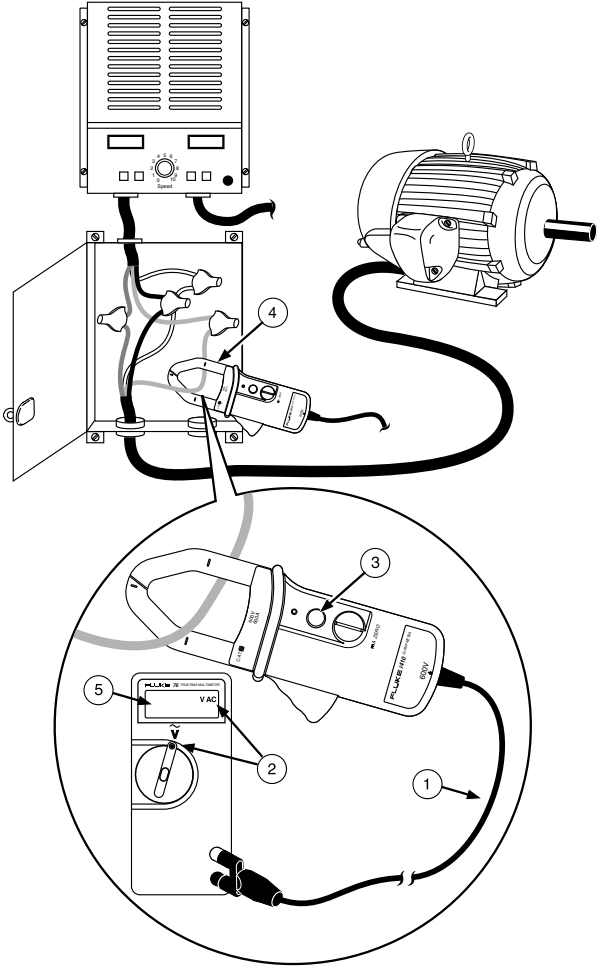

ar003i.eps

- 1 Connect to voltmeter.
- 2 Select mV ac (or V ac, but resolution may be limited to 1 A.)
- 3 Set ON.
- 4 Clamp and center around conductor.
- 5 Read voltmeter (1 mV = 1 A.)

Testing the Battery

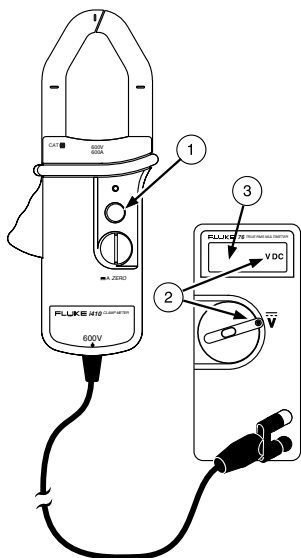

- ① Set OFF.
- ② Select V dc.
- ③ ≤ 7.0 V dc = replace battery.
(Voltmeter input impedance ≥ 1 M Ω)

ar004i.eps

Replacing the Battery

For specified battery life, use an alkaline battery.

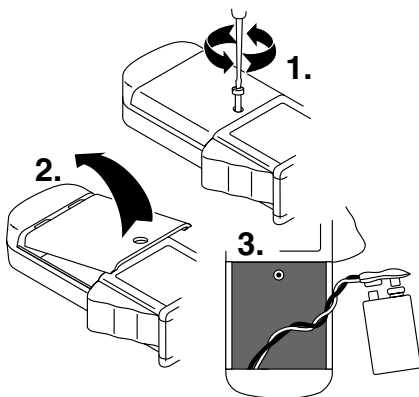

ar005i.eps

If the Current Clamp Does Not Work

Check	Correct
Battery = OK?	Refer to "Testing the Battery."
Voltmeter connections?	Red to + or $V\Omega$  Black to COM
Voltmeter function/range?	mV dc mV ac (or V ac)

Storage

During longer periods of non-use (> 60 days), remove and store the battery separately.











Cleaning

Periodically wipe the case with a damp cloth and mild detergent. Do not use abrasives or solvents.

Service and Parts

The Current Clamp should be serviced only by a qualified service technician. For service information, contact your nearest Fluke dealer or service center.

Symbols

	May be used on HAZARDOUS LIVE conductors.
	Equipment protected by double or reinforced insulation.
	Risk of Danger. Important information. See Instruction Sheet.
	Risk of Electric Shock.
	Complies with U.S. and Canadian standards: UL61010-1; CAN/CSA C22.2 No. 61010-1 (2004) & No. 61010-2-032 (2004)
	Inspected and licensed by TÜV Product Services.
 N10140	Conforms to relevant Australian standards.
	Conforms to IEC 61010-1 2nd Edition & IEC 61010-02-032
	Earth ground
	AC (Alternating Current)
	DC (Direct Current)

Specifications

Operating Temperature	-10 °C to +50 °C (14 °F to 122 °F)
Storage Temperature	-20 °C to +60 °C (-4 °F to +140 °F)
Relative Humidity	0 % to 95 % (0 °C to 30 °C) 0 % to 75 % (30 °C to 40 °C) 0 % to 45 % (40 °C to 50 °C)
Altitude Operating Non-operating	0 m – 2000 m 0 m – 12000 m
Battery Type	9 V (alkaline) NEDA 1604 IEC 6F22
Battery Life	60 hrs typical (continuous with alkaline)
Safety	 Double Insulation, 600 V rms, CAT. III
Current x Hz Product	≤ 240,000
Output Signal	1 mV per amp dc or ac
Working Voltage	600 V rms, CAT. III maximum at input
Maximum Conductor Size	1 ea. 30 mm (1.18 in.) diameter 2 ea. 25 mm (0.98 in.) diameter
Load Impedance	≥1 MΩ, ≤100 pF
Temperature Coefficient	+/- (0.05 x accuracy per °C (0 °C – 18 °C, 28 °C – 50 °C))
Size	209 mm x 78 mm x 48 mm (3.09 in. x 8.21 in. x 1.87 in.)
Weight	0.5 kg (17.6 oz.)

	i410	i1010
Specified Current Range:	1 A – 400 A ac rms * 1 A – 400 A dc	1 A – 600 A ac rms * 1 A – 1000 A dc
Usable Current Range:	0.5 A – 400 A	0.5 A – 1000 A
DC Accuracy (zero adjusted, conductor centered)	3.5 % + 0.5 A (0 A – 400 A)	2.0 % + 0.5 A (0 A – 1000 A)
AC Accuracy	3.5 % + 0.5 A, 45 Hz – 400 Hz, Crest Factor ≤ 3. (0 A – 400 A)	2.0 % + 0.5 A, 45 Hz – 400 Hz, Crest Factor ≤ 3. 3.0 % + 0.5 A, 400 Hz - 2 kHz sine wave. (0 A – 600 A)
Bandwidth	3 kHz	10 kHz
* With a true-rms voltmeter, the minimum ac current is limited to the low end of the specified mV ac range.		

LIMITED WARRANTY & LIMITATION OF LIABILITY

Each Fluke product is warranted to be free from defects in material and workmanship under normal use and service. The warranty period is one year and begins on the date of shipment. Parts, product repairs, and services are warranted for 90 days. This warranty extends only to the original buyer or end-user customer of a Fluke authorized reseller, and does not apply to fuses, disposable batteries, or to any product which, in Fluke's opinion, has been misused, altered, neglected, contaminated, or damaged by accident or abnormal conditions of operation or handling. Fluke warrants that software will operate substantially in accordance with its functional specifications for 90 days and that it has been properly recorded on non-defective media. Fluke does not warrant that software will be error free or operate without interruption.

Fluke authorized resellers shall extend this warranty on new and unused products to end-user customers only but have no authority to extend a greater or different warranty on behalf of Fluke. Warranty support is available only if product is purchased through a Fluke authorized sales outlet or Buyer has paid the applicable international price. Fluke reserves the right to invoice Buyer for importation costs of repair/replacement parts when product purchased in one country is submitted for repair in another country.

Fluke's warranty obligation is limited, at Fluke's option, to refund of the purchase price, free of charge repair, or replacement of a defective product which is returned to a Fluke authorized service center within the warranty period.

To obtain warranty service, contact your nearest Fluke authorized service center to obtain return authorization information, then send the product to that service center, with a description of the difficulty, postage and insurance prepaid (FOB Destination). Fluke assumes no risk for damage in transit. Following warranty repair, the product will be returned to Buyer, transportation prepaid (FOB Destination). If Fluke determines that failure was caused by neglect, misuse, contamination, alteration, accident, or abnormal condition of operation or handling, including overvoltage failures caused by use outside the product's specified rating, or normal wear and tear of mechanical components, Fluke will provide an estimate of repair costs and obtain authorization before commencing the work. Following repair, the product will be returned to the Buyer transportation prepaid and the Buyer will be billed for the repair and return transportation charges (FOB Shipping Point).

THIS WARRANTY IS BUYER'S SOLE AND EXCLUSIVE REMEDY AND IS IN LIEU OF ALL OTHER WARRANTIES, EXPRESS OR IMPLIED, INCLUDING BUT NOT LIMITED TO ANY IMPLIED WARRANTY OF MERCHANTABILITY OR FITNESS FOR A PARTICULAR PURPOSE. FLUKE SHALL NOT BE LIABLE FOR ANY SPECIAL, INDIRECT, INCIDENTAL, OR CONSEQUENTIAL DAMAGES OR LOSSES, INCLUDING LOSS OF DATA, ARISING FROM ANY CAUSE OR THEORY.

Since some countries or states do not allow limitation of the term of an implied warranty, or exclusion or limitation of incidental or consequential damages, the limitations and exclusions of this warranty may not apply to every buyer. If any provision of this Warranty is held invalid or unenforceable by a court or other decision-maker of competent jurisdiction, such holding will not affect the validity or enforceability of any other provision.

Fluke Corporation
P.O. Box 9090
Everett, WA 98206-9090
U.S.A.

Fluke Europe B.V.
P.O. Box 1186
5602 BD Eindhoven
The Netherlands

